

SHEET 1 OF 3	REV A	ECO 3325	MODEL #:	S5506XXC	TITLE:	M3i - INDOOR CYCLE	
FROM SERIAL NUMBER:	140527-84571	TO:	PRESENT	DATE FROM:	5/27/2014	TO:	PRESENT

- 39 INCLUDES ITEMS: 4 10 26 27
45 61 101

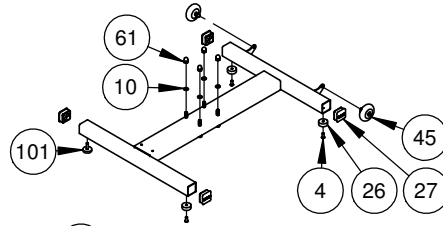

- 40 INCLUDES ITEMS: 11 25 76 77
78 98

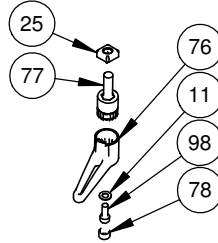

- 45 INCLUDES ITEMS: 9 19 20 65 96

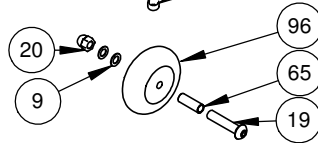

- 46 INCLUDES ITEMS: 1 6 23 35
52 60 80 100

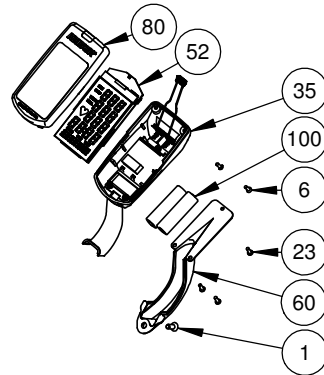

- 47 INCLUDES ITEM: 90

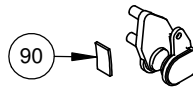

- 48 INCLUDES ITEMS: 50 59 70 93

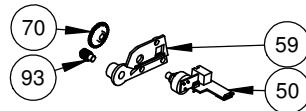

- 49 INCLUDES ITEMS: 2 3 5 7 8 13 14 17 18 24
28 29 32 34 36 37 38 42 47 48
51 54 57 66 67 69 71 72 73 74
81 82 84 85 86 87 88 89 91 93
94 95 99

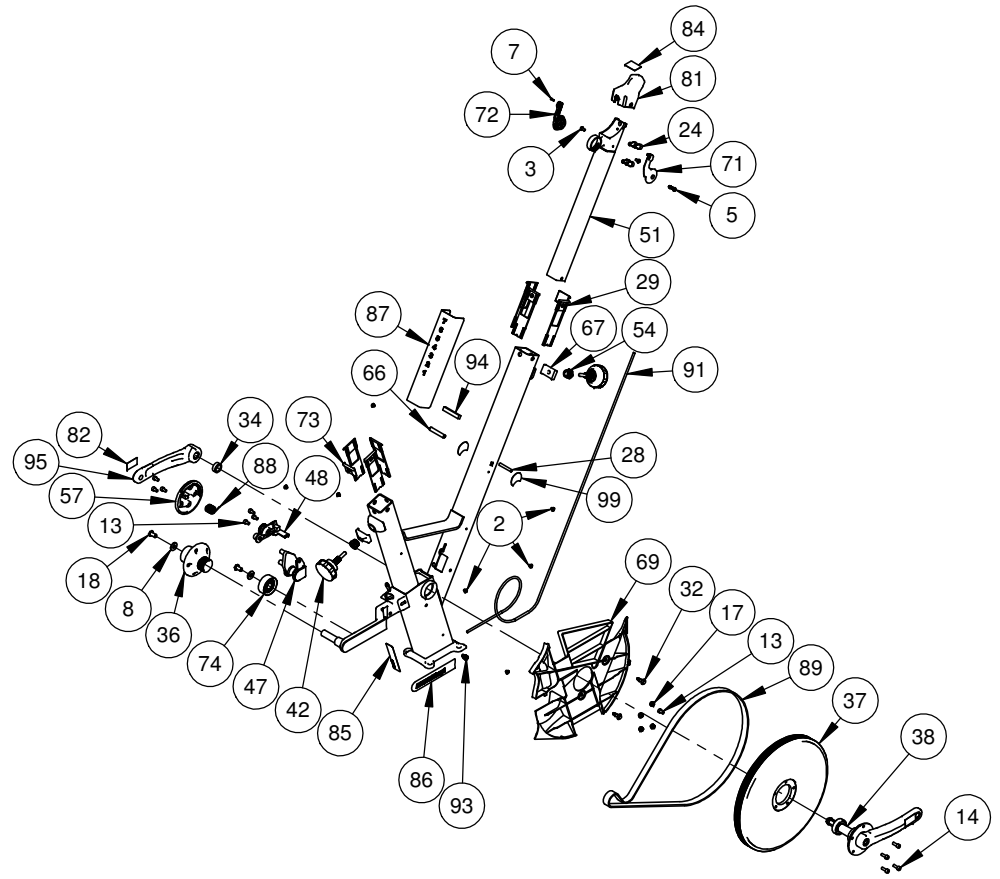

ITEM NO.	QTY.	PART NO.	TITLE	ITEM NO.	QTY.	PART NO.	TITLE	ITEM NO.	QTY.	PART NO.	TITLE
1	1	9062	SCREW - CRFCHMS 10-32 X 1/2 SS	45	2	550852	SA-WHEEL-TRANSPORT	89	1	555406	BELT - POLY V
2	7	9253	SCREW - CRPHMS #10-32 X 3/16 SS	46	1	550853X	SA - DISPLAY-COMPUTER	90	1	555410	PAD - BRAKE-FRICTION
3	2	9261	SCREW - CRPHMS 10-32 X 3/8 SS	47	1	550868	SA - MAGNET HOLDER	91	1	555411	SHIFT CABLE
4	3	9279	SCREW - SBHTS-TF 5/16-18 X 3/4 ZP	48	1	550869	SA - CIRCUIT BOARD-PICKUP-MXi	92	1	555413	CORD - COMP TO PICKUP
5	1	9287	SCREW - CRPHTS 10-24 X 3/4 SS	49	1	550870XXC	SA-MAIN FRAME-FTB-XXC-MXi	93	2	555419	SCREW - HSPSS-M10x1.5 X 16 BLK
6	3	9303	SCREW - CRPHTCS-T25 4 X 3/8 SS	50	1	550911	CKT BRD - PICKUP	94	1	555420	SWEAT STRIP - 5/16 X 3/8
7	1	9304	SCREW - CRFCS-PLASTITE 4-20 X 3/8 SS	51	1	550922	SLIDE MT - TUBE	95	1	555421	CRANK ARM - L
8	2	9344	WASHER - FW-USS 5/16 ZP	52	1	550929	CKT BRD-COMPUTER-BL-BT	96	2	555446	WHEEL - 3 IN-W/BUSHING
9	4	9369	WASHER - ACFT 5/16 SS	53	1	553101	TUBE - WHEEL GUARD-270	97	1	555457	SADDLE - M3X
10	4	9384	WASHER - FW-ACFT 7/16 SS	54	2	554997	THREADED INSERT - 3/4 X 1/2 SS	98	2	555459	SCREW - SHCS M6x1 X 16 SS-PATCHED
11	2	9391	WASHER - FW-ACFT 1/4 SS	55	1	555003	FLYWHEEL	99	2	565407	COVER-SQ PIN HOLE
12	2	9397	WASHER - BONDED 5/16 SS	56	1	555005	HUBCAP - FLYWHEEL	100	2	966502	BATTERY - AA CELL
13	7	9500	SCREW - SHCS M6x1 X 10 SS	57	1	555008	MAGNET COVER	101	1	995420	BUMPER - MOLDED GLIDE-W-SCREW
14	4	9501	SCREW - SHCS M6x1 X 16 SS	58	1	555009	SLIDER - SEAT				
15	5	9502	SCREW - SHCS M6x1 X 20 SS	59	1	555011	PLATE - MAGNET SUPPORT				
16	1	9508	NUT - HN M6X1 SS	60	1	555017	MOUNT - DISPLAY-COMPUTER				
17	4	9509	NUT - HELN M6X1 ZP	61	4	555022	NUT - HAN-HC-7/16-20 SS				
18	2	9511	SCREW - HHCS M8X1.25 X 16 ZP	62	2	555025	CLAMP - WHEEL GUARD				
19	2	9516	SCREW - SBHCS M8x1.25 X 45 SS	63	1	555026	BOTTOM SLIDE - HANDLEBAR ADJ				
20	2	9519	NUT-HAN-HC M8x1.25 SS	64	1	555031	SPACER - HANDLEBAR ADJ				
21	2	9524	SCREW - SBHCS M8x1.25 X 16 SS	65	2	555037	SPACER - 032039114				
22	1	9525	SCREW - HHCS M6X1 X 45 SS	66	1	555039	PIN - MF-5/16 SQ X 2 1/8				
23	3	9532	SCREW-CRPHMS 4-40 X 3/8 SS	67	2	555048	PLATE - FRICTION W/HOLE				
24	4	9536	SCREW - SHCS M8x1.25 X 16 SS	68	1	555051	COVER - BELT-MAIN				
25	1	9982	NUT-HEAVY SQ. 3/8-16 SS	69	1	555052	COVER - BELT-INNER				
26	3	105423	BUMPER - MOLDED GLIDE	70	1	555053	GEAR - POT				
27	4	115054	PLUG - 2 IN SQ-KEISER	71	1	555054	SHIFTER - R				
28	1	505063	PIN - HANDLEBAR-1/4 X 1-3/4	72	1	555055	SHIFTER - L				
29	6	505068	BUSHING - 4 PIECE	73	2	555058	BUSHING - SHORT				
30	2	505173	STRAP - PEDAL	74	1	555066	PULLEY - IDLER-MOLDED				
31	1	505444	TOE CLIP & STRAP SET ASSY	75	1	555073	CAP - WHEEL GUARD-BOT				
32	2	505480	RIVET - 1/4 X 3/4 REM PLUG	76	2	555074	HANDLE - L-BLACK				
33	1	540831	PEDAL SET - COMBO	77	2	555075	HANDLE - STUD-BLACK				
34	1	543091	HOSE - SPACER-LONG	78	2	555076	CAP - M6 SHCS-BLACK				
35	1	550802	BACK - DISPLAY-COMPUTER	79	1	555078	GUARD - SWEAT-HANDLEBAR-SHORT				
36	1	550808	SA - HUB-FLYWHEEL	80	1	555079	FACE - DISPLAY-COMPUTER-BL				
37	1	550811	SA - PULLEY-330MM DIA	81	1	555080	COVER - DISPLAY MT				
38	1	550813X	SA - CRANK ARM-R AXLE SET	82	1	555371	DECAL - CAUTION-PEDAL TORQUE				
39	1	550814	SA - FRAME-BASE	83	1	555375	DECAL - CAUTION-HANDLEBAR & SEAT				
40	1	550828	SA - HANDLE-L	84	1	555376	DECAL - WARNING-HEART RATE				
41	1	550844	SA - HANDLEBAR-NEUTRAL-FTB	85	1	555381	DECAL - SERIAL NUMBER - M3				
42	2	550847	PLUNGER KNOB	86	1	555385	DECAL - DOME-KEISER M3I				
43	1	550850	SA - SEATPOST	87	1	555386	DECAL - HANDLEBAR-POSITION-BLK				
44	1	550851X	SA-COVER-LOWER-MF	88	1	555405	SPRING - TORSION				

SHEET 3 OF 3	REV A	ECO 3325	MODEL #: 5506XXC	TITLE: M3i - INDOOR CYCLE
FROM SERIAL NUMBER: 140527-84571	TO: PRESENT	DATE FROM: 5/27/2014	TO: PRESENT	

PRINTED ON: 1/5/2015

X:\drawings_REVISION55_EC_RWD_BIKE